



## Summary

1. Handling
  - 1.1. General advices
  - 1.2. Setting to work
  - 1.3. Switch on/off
  - 1.4. Menu
    - 1.4.1. Measuring unit switching (UNIT)
    - 1.4.2. Probe selection (Prob)
    - 1.4.3. Difference temperature (Lin2)
    - 1.4.4. Calibration (CAL)
      - 1.4.4.1 Calibration combination probe (temperature/humidity)
    - 1.4.5. Printer port (PrEn)
    - 1.4.6. Channel activation (Chnl)
  - 1.5. Recalling memory data (HOLD/MAX/MIN/AVG)
  - 1.6. Measuring rate (FAST-modus)
  - 1.7. AUTO-OFF-function
  - 1.8. Special-functions
2. Power supply / Changing the battery
3. Error codes / troubleshooting
4. Technical data
5. Interface protocol RS232
6. Connector layout
7. Data of probe-calibration
8. Connector layout
9. Guarantee

# 1. Handling

## 1.1 General advice

- For cleaning the instrument please do not use abrasive cleaner but a dry or wet piece of cloth.
- Please store the measuring instrument in a dry and clean place.
- Avoid any force like shocks or pressure to the instrument.
- Do not use force to connect the probe or interface plugs in. The interface plug is different from the probe plug.
- If no sensor is connected to the instrument while switching on „open“ shows on the display (Please refer to chapter error codes/troubleshooting).
- A retractable stand on the back of the instrument allows it to be used as a bench top instrument.

## 1.2 Operation

Before switching on the instrument, connect the probe/s to the instrument and insert the battery (Please refer to chapter 6. Power supply / battery changing). A number on the instrument's housing marks each port.

## 1.3 Switching on and off

By operating the ON/OFF-key the instrument switched on or off. After switching on the instrument indicates a full segment test for 1,5 sec., afterwards the instrument shows the calibration-code and the adjusted measurement category for channel 1. (Only 2-channel instruments: After additionally 1,5 sec. the instrument shows the calibration-code and the adjusted measurement category for channel 2.) Then it starts operating in measurement mode indicating the actual measurement value (for example: temperature). All instruments display the measurement value of channel 1 on the top display line (big display line). Directly below you will see the trending bargraph. The second channel of our 2-channel instruments you will see on the bottom line (small display line).

Fig 1.: Example of channel information after switching on.:



### channel 1:

Line 1: **CoFF P** = calibration code of channel 1 according to DIN, probe selection of channel 1 = Pt100.



### channel 2:

Line 2: **CoFF P** = calibration code of channel 2 according to DIN, probe selection of channel 2 = Pt100.

**Note:** On all instruments you can select the measurement category (chapter 1.4.2. Prob) according to the model version. Instruments that are delivered only with one probe the correct measurement category is preset. In other case please check chapter 1.4.2. (Prob) for the correct set-up.

## 1.4 Menu

The adjustments of the instruments like the measurement value, calibration of probes, deactivation of channels and so on are resulting from the structure of the menu. You will reach into the main menu by pushing [ENTER/MENUE]. With the up and down keys [↑↓] you can choose your required menu item. Push [ESC] to be back in the measuring mode.

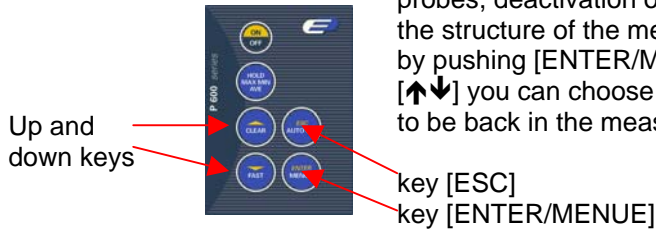

### Menu structure

Unit <small>For channel 1+2</small>	Prob <small>For channel 1+2</small>	Lin2	CAL <small>For channel 1+2</small>	PrEn	Chnl <small>For channel 1+2</small>
°C	P	T1-T2	OFF	OFF	OFF
°F	J		OP1	ON	ON
m/s	K		OP2		
%rh	L				
g/m <sup>3</sup>	N				
°C td	R				
°F td	S				
	T				
	RH				
	D				

### 1.4.1 Measuring unit switching °C and °F respective %rH, td or g/m<sup>3</sup> / [Unit]

#### Unit = Measuring unit

Measuring unit temperature (°C=Celsius, °F=Fahrenheit)

Measuring unit humidity (%rH=relative humidity, td=dew point, g/m<sup>3</sup>=absolute humidity)

To change the measuring unit push [ENTER/MENUE]. Use the up and down keys [↑↓] to select **Unit**. Push again [ENTER/MENUE]. On the left corner of the display appears a small **1**, which indicates the selected channel. For changing the channel use the up and down keys [↑↓]. Push [ENTER/MENUE] to confirm. On the right corner of the display appears °C or °F, or %rH, td or gm<sup>3</sup> (depending on the selected probe). Use the up and down keys [↑↓] again to adjust the requested measuring unit and push [ENTER/MENUE] to confirm. Push [ESC] to be back in the measuring mode.

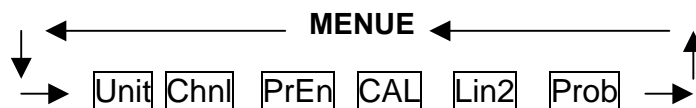

### 1.4.2 Probe selection / [Prob]

Push [ENTER/MENUE] to change a probe. Use the up and down keys [↑↓] to select **Prob**. Push [ENTER/MENUE] to confirm. On the left corner of the display appears a small **1**, which indicates the selected channel. For changing the channel use the up and down keys [↑↓]. Push again [ENTER/MENUE] to confirm. On the right corner of the display appears the active probe. Use the up and down keys [↑↓] to change the probe. Push [ENTER/MENUE] to confirm the requested probe. Push [ESC] to be back in the measuring mode.

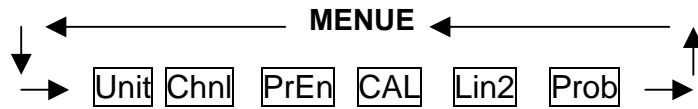

#### Available probes:

Measurement category	Probe selection (Prob)	LC-Display	Suitable for these types of measuring instruments:
Temperature	Pt100 (RTD)	P	P600/P605/P650/P655/P670
Temperature	Fe-CuNi Type J	J	for all P600-instruments
Temperature	NiCr-Ni Type K	K	for all P600-instruments
Temperature	Fe-CuNi Type L	L	for all P600-instruments
Temperature	NiCrSi-NiSi	n	for all P600-instruments
Temperature	Pt13Rh-Pt	r	P600/P605/P650/P655/P670
Temperature	Pt10Rh-Pt	S	P600/P605/P650/P655/P670
Temperature	Cu-CuNi	f	for all P600-instruments
Humidity	%rH	rh	P650/P655/P670
Flow	m/s	d	P650/P655/P670

**Note:** Please check the probe selection to be sure that the correct probe is entered. If a measurement value is changed with the ENTER-key at the menu **Prob**, the standard calibration will be automatically used.

**Indications for the combination probes (temperature and humidity):**

Please adjust relative humidity as measurement value for the channel on which the combination probe is plugged. If you want that the measured temperature of the plugged combination probe is shown as well, you have to deactivate the channel on which no probe is plugged on (see chapter 1.4.6./**Chnl**)

**1.4.3 Difference temperature (only 2-channel instruments) / [Lin2]**

To display the difference temperature push [ENTER/MENUE]. Use the up and down keys [↑↓] to select **Lin2**. Push again [ENTER/MENUE]. On the right corner of the display appears a  $T_1-T_2$ . Use the up and down keys [↑↓] to adjust the requested selection. Push [ENTER/MENUE] to confirm. Push [ESC] to be back in the measuring mode.

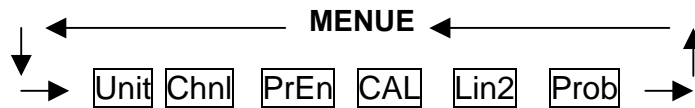

**Note:** Both channel have to be activated for showing the difference temperature.

#### 5.4.4 Calibration function / [CAL]

Despite high quality manufacturing techniques, each probe is slightly different from specified standards. To eliminate inaccuracies caused by exchanging or ageing of probes, the instrument offer easy calibration functions which guarantee that the system accuracy is always as good as if the instrument was specifically calibrated to the individual probes in our laboratory.

##### The instruments offer three calibration options:

- 1) [OFF]: Standard characteristic curve (e.g. Pt100-resistance according DIN IEC 60751)
- 2) [OP1]: Calibration by code (2 x four digit code) is equivalent to a 2-point calibration  
The code is marked clearly by a label on each standard probe.
- 3) [OP2]: Calibration by physical standard references (1-point, 2-point or 3-point calibration)

##### CAL = calibration

Push [ENTER/MENUE] to calibrate the instrument with sensor. Use the up and down keys [↑↓] to select **CAL**. Push again [ENTER/MENUE]. On the left corner of the display appears a small **1**, which indicates the selected channel. For changing the channel use the up and down keys [↑↓]. Push [ENTER/MENUE] to confirm

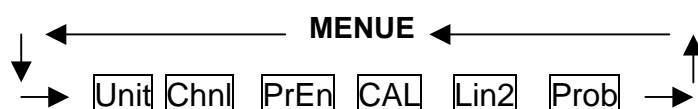

Use the up and down keys [↑↓] to select the requested calibration option. Push [ENTER/MENUE] to confirm.

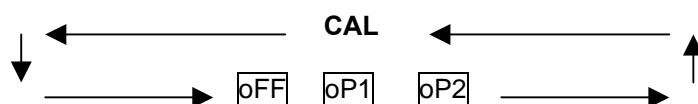

##### Standard calibration according DIN IEC 60751 / [oFF]

Use the up and down keys [↑↓] to select **[oFF]**. Push [ENTER/MENUE] to confirm. Push [ESC] to be back in the measuring mode.

##### Calibration by code / oP1

Use the up and down keys [↑↓] to select **oP1**. Push [ENTER/MENUE] to confirm. On the bottom of the display appears a very small **1**, after this number a four-digit number (Hex-Code/0..F) is displayed. For changing the number use the up key [↑]. For stepping to the next number use the down key [↓]. If the requested number is complete then push [ENTER/MENUE] to confirm. Now on the bottom of the display appears a very small **2**, after this number a second four-digit number is displayed. For changing the number please follow the manual as before. Push [ESC] to be back in the measuring mode.

**Note:** After confirming **oP1** by pushing [ENTER/MENUE] the function **oP1** (calibration by code) is activated, even though you leave the menu by pressing [ESC].

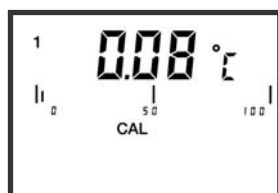

Display-indication with active calibration code(OP1):

The **CAL**-segment and the small **1** on the left indicates to the user that **oP1** is activated.

## Calibration by physical standard references / oP2

Use the up and down keys [↑↓] to select **oP2**. Push [ENTER/MENUE] to confirm. On the bottom of the display appears **1 P**. For changing between a 1-Point **1 P**, 2-Point **2 P** or 3-Point **3 P** - calibration use the up and down keys [↑↓].

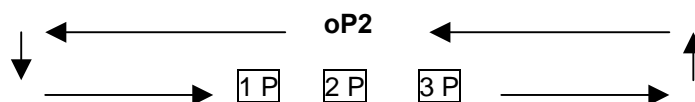

### Example of a 1-Point calibration:

Push [ENTER/MENUE] to confirm. On the display appears **Go**. After the displayed measuring value is stable push [ENTER/MENUE]. App. 2 seconds later in the first display line appears **P1** (measuring value 1); in the second display line appears **dP**. (standing for decimal point).

Use the up and down keys [↑↓] to select the number of digits after decimal point.

**dP.** = two decimal digits

**dP .** = one decimal digit (decimal point is jumping one digit to the right)

Push [ENTER/MENUE] to confirm. On the second line of the display appears **Si -**.

Use the up and down keys [↑↓] to select the requested sign.

**Si \_** = reference standard shows a negative measuring value (below 0,00°C)

**Si |** = reference standard shows a positive measuring value (above 0,00°C)

Push [ENTER/MENUE] to confirm. On the second line of the display appears **Fd 0**.

Use the up and down keys [↑↓] to select the requested range:

**Fd 0** = below 100,00°C

**Fd 1** = above 100,00°C

Push [ENTER/MENUE] to confirm. On the display appears **00.00**. For changing the value use the up key [↑]. For stepping to the next number use the down key [↓]. If the requested value is complete then push [ENTER/MENUE] to confirm.

Push [ESC] to be back in the measuring mode.

**Important:** A break of the physical calibration cannot be done by the [ESC]-button. Switching off the instrument can only do a break of the physical calibration.

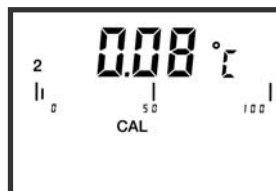

Display-indication with active calibration code(OP2):

The **CAL**-segment and the small **2** on the left indicates to the user that **oP2** is activated.

### 1.4.4.1 Calibration function of the combination probe (humidity/temperature) [CAL]

Each humidity probe of Dostmann electronic is a combination probe. That means that beside the humidity sensor these probes also contain a temperature sensor. Both measurement values are plugged in the same channel over one probe. Before the calibrating of both measurement values (humidity and temperature) the calibrated measurement value must be adjusted at the menu item **Prob(Probe selection 1.4.2)**.

#### The instruments offer three calibration options:

- 1) [OFF]: Standard characteristic curve (no specific probes correction will be carried out)
- 2) [OP1]: Calibration by code (2 x four digit code) is equivalent to a 2-point calibration  
The code is marked clearly by a label on each standard probe/rH = humidity & P°C = temperature.
- 3) [OP2]: Calibration by physical standard references (1-point, 2-point or 3-point calibration) is only for the measurement value rH humidity possible

#### CAL = calibration

Push [ENTER/MENUE] to calibrate the instrument with sensor. Use the up and down keys [↑↓] to select **CAL**. Push again [ENTER/MENUE]. On the left corner of the display appears a small **1**, which indicates the selected channel. For changing the channel use the up and down keys [↑↓]. Push [ENTER/MENUE] to confirm

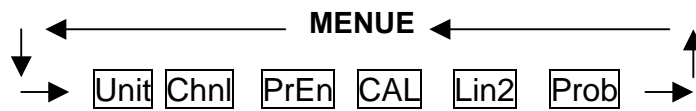

With the up and down keys [↑↓] you can now choose between rH for calibration of humidity and P°C for calibration of temperature.

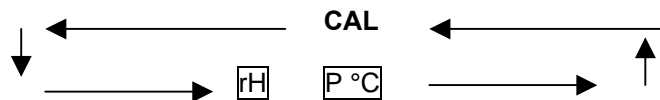

Use the up and down keys [↑↓] to select the requested calibration option. Push [ENTER/MENUE] to confirm.

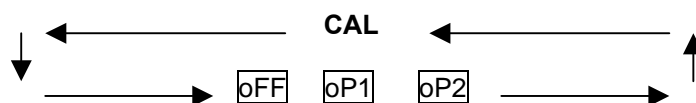

#### Standard calibration according DIN IEC 60751 / [oFF]

Use the up and down keys [↑↓] to select [oFF]. Push [ENTER/MENUE] to confirm.

#### Calibration by code / oP1

Use the up and down keys [↑↓] to select **oP1**. Push [ENTER/MENUE] to confirm the desired setting. On the bottom of the display a small **1** appears, after this number a four-digit number (Hex-Code /0..F) is displayed. For changing the number use the up key [↑]. For stepping to the next number use the key down [↓]. If the requested number is complete then push [ENTER/MENUE] to confirm. Now on the bottom of the display appears a small **2** and after this number a second four-digit number is displayed. For changing the number please follow the manual as before. Push [ESC] to be back in the measuring mode.



#### 1.4.5 Printer port / [PrEn]

**PrEn = Printer enable = Drucker aktivieren**

Push [ENTER/MENUE] to activate or deactivate the printer port. Use the up and down keys [↑↓] to select **PrEn**. Push again [ENTER/MENUE]. Use the up and down keys [↑↓] to activate **on** or deactivate **off** the requested adjustment and push [ENTER/MENUE] to confirm. Push [ESC] to be back in the measuring mode.

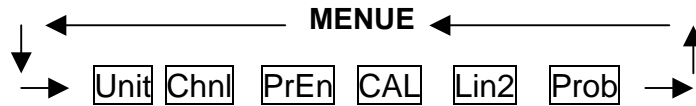

#### 1.4.6 Channel activation (only 2-channel instruments) / [Chnl]

**Chnl = channel**

To activate or deactivate a measuring channel push [ENTER/MENUE]. Use the up and down keys [↑↓] to select **Chnl**. Push again [ENTER/MENUE]. On the left corner of the display appears a small **1**, which indicates the selected channel. For changing the channel use the up and down keys [↑↓]. Push [ENTER/MENUE] to confirm. Use the up and down keys [↑↓] again to activate **on** or deactivate **off** the requested measuring channel and push [ENTER/MENUE] to confirm. Push [ESC] to be back in the measuring mode.

**Note:** As a minimum one channel is active!

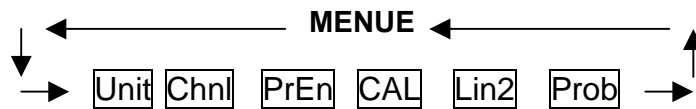

### 1.5 Recalling the memory data (HOLD MAX MIN AVE)

After pushing first time the key [HOLD MAX MIN AVE] the actual value will be hold on the top display line (big display). Pushing again the key [HOLD MAX MIN AVE], the saved maximum-, minimum and average value will be displayed in the bottom display line (small display).

Note for 2-channel instruments: First the MAX-MIN-AVE-values of channel 1 will be displayed – afterwards the values of the channel 2 will be displayed. Is there only one probe on a 2-channel instrument we suggest to deactivate the channel without probe (menu Chnl).

**Note:** During the recall of the memory data the extremes (MAX MIN) and the average value (AVE) will not be calculated or carried on.

### Clearing the memory (MAX MIN AVE)

Press [CLEAR] key once to erase the stored maximum, minimum and average from memory. On the display appears **Clr.** – After erasing the memory the instrument automatically switches back to measuring mode indicating the actual measured value again.

### 1.6 Measuring rate (FAST-mode)

Press [FAST/↓] key once to change the measuring rate. Now the measuring rate is app. 4 measurements per second. Press [FAST/↓] key again and the instrument is back in the standard mode (1 measurement per second).

**Note:** In the fast mode the battery consumption is three times higher than in the standard mode.

### 1.7 AUTO-OFF-function

**EaOf** = Enable Auto-off  
**dAoF** = Disable Auto-off

Press [ESC/AUTO-OFF] key once. On the display appears **EaOf**. Now the instrument switches off automatically after app. 30 minutes. Press [ESC/AUTO-OFF] key again. On the display appears **dAoF**. Now the Auto-Off-function is deactivated.

**Note:** After switching off and on the instrument, the Auto-Off function is automatically activated.

### 1.8 Special-functions (Ohm/Micro volt/Volt/Hertz-display)

If you want to get the shown value displayed according to the basic units you will have to push, when you switch on, the keys FAST and ON/OFF at the same time for approximately 3 seconds till the next basic unit appears:

**o** = Ohm (Pt100)  
**H** = Hertz (flow m/s)  
**u** = Micro volt (thermocouples)  
**U** = Volt (humidity)

## 2. Power supply

For the power supply of the instrument a 9 Volt dry battery is used. To exchange the battery switch of the instrument and open the battery cover on the backside of the instrument. Remove and disconnect the battery from the instrument. Connect a new 9 V battery to the plug and put the battery back into the instrument.

By showing the „BAT“ segment the instrument indicates, that the battery has to be exchanged. After showing the „BAT“ segment the instrument allows app. 1 hour of further measuring.

**Note:** For protection of our environment please don't put the battery into household garbage but use separate disposal.

## 3. Error Codes

By displaying the following error codes the instrument support the operation of the instrument.

### 8. Error      Meaning

Open	no probe or wrong probe is connected
Hex R	environment temperature below working temperature

#### 4. Technical data

### Hand-held instruments, series P600

	P600/P605	P610/P615
<b>Inputs</b>	Pt100, thermocouple: type K, J, L, N, R, S, T	thermocouple: type K, J, L, N, T
<b>Measuring range</b>		
Pt100	-200...+850°C	---
Thermocouple	according DIN (-200...1760°C)	according DIN (-200...1370°C)
<b>Accuracy</b>		
Pt100	+0,1°C from -100°C...+200°C 0,1% remaining range	---
thermocouple R, S	+1,0°C +0,1%	---
thermocouple K, J, L, N, T	+0,3°C from 0°C...+200°C +1,0°C to 1000°C +1,5°C remaining range	+0,3°C from 0°C...+200°C +1,0°C to 1000°C +1,5°C remaining range
<b>Resolution</b>	0,1°C	0,1°C
<b>Ex-mark</b>	---	---

	P650/P655	P670
<b>Inputs</b>	Pt100, thermocouple: type K, J, L, N, R, S, T, humidity, flow,	Pt100, thermocouple: type K, J, L, N, R, S, T, humidity, flow,
<b>Measuring range</b>		
Pt100	-200...+850°C	-200...+850°C
Thermocouple	according DIN (-200...1760°C)	according DIN (-200...1760°C)
Humidity	0 %...100 %rF	0 %...100 %rF
Flow	0 ... 40 m/s	0 ... 40 m/s
<b>Accuracy</b>		
Pt100	+0,03°C from -100°C...+150°C +0,05°C from -200°C...+200°C, otherwise 0,1%	+0,1°C from -100°C...+200°C otherwise 0,1%
Thermocouple R, S	+1,0°C +0,1%	+1,0°C +0,1% v.M.
Thermocouple K, J, L, N, T	+0,3°C from 0°C...+200°C +1,0°C ... 1000°C +1,5°C remaining range	+0,3°C from 0°C...+200°C +1,0°C ... 1000°C +1,5°C remaining range
Humidity	+1,5%rH	+1,5%rH
Flow	0,5% of end value	0,5% of end value
<b>Resolution</b>	0,01°C from -200°C...+200°C, otherwise 0,1°C, respectively 0,1%	0,1°C, 0,1% and 0,1 m/s
<b>Ex-mark</b>	---	---

#### For all instruments

<b>Connectors</b>	DIN 8-pole
<b>Allowable operating temperature</b>	0°C ... +40°C
<b>Display</b>	2-line LCD
<b>Housing</b>	plastic
<b>Dimensions</b>	200 x 85 x 40 mm (LxWxH)
<b>Weight</b>	300 g
<b>Power supply</b>	9 V battery
<b>Battery life</b>	appr.. 20 h.

## 5. RS232 Interface protocol

During the data transmission it has to be guaranteed that the tension level for RTS = + 12V and DTR = -12 V are available through the PC. This has to be assured through a regulation code of the software.

**Parameter:**    **Baud rate**    **2400 baud**  
                   **Datenbits**    **8**  
                   **Stopbits**     **2**  
                   **Parität**       **None**

To start the data transmission you have to send the following characters. The following index shows you which value can be requested over the interface.

<b>P600</b>	
Measuring value 1 + 2 autom. recognize	FC (hex)
Enabling the keyboard	0 (hex)

Attention: By sending the command FC(hex) you will get the complete data, the instrument lock automatically the keyboard. To release the keyboard you have to send the command 0(hex).

The datas would be sent in the following format.

### Data Type = String

The length of the string depends on the instrument (a two-channel or one-channel instrument).

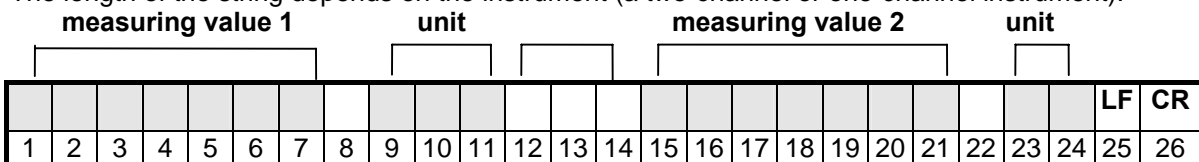

### Example: Turbo Pascal Source-Code for initialisation of the RS232 interface

```
PROCEDURE V24oeffnen(com1,com2:Boolean); { initialisation of RS 232 }
```

```
  VAR wert          : Byte;
BEGIN
  IF com1 THEN BEGIN { initialisation of COM 1 }
    PORT [$3FB]:=128; { activate baud rate }
    PORT [$3F8]:= 48; { baud rate - LSB, 2400 baud }
    PORT [$3F9]:= 0;  { baud rate - MSB }
    PORT [$3FB]:= 7;  { 8 Bits, No Parity, 2 Stop }
    PORT [$3FC]:= 2;  { DTR = 0, RTS = 1 }
    Wert := PORT [$3F8] { receiving register empty }
  END;
END;
```

6. Connector layout

Connector layout Pt100 4-wire (series P600)

Measuring channel 1 / 2

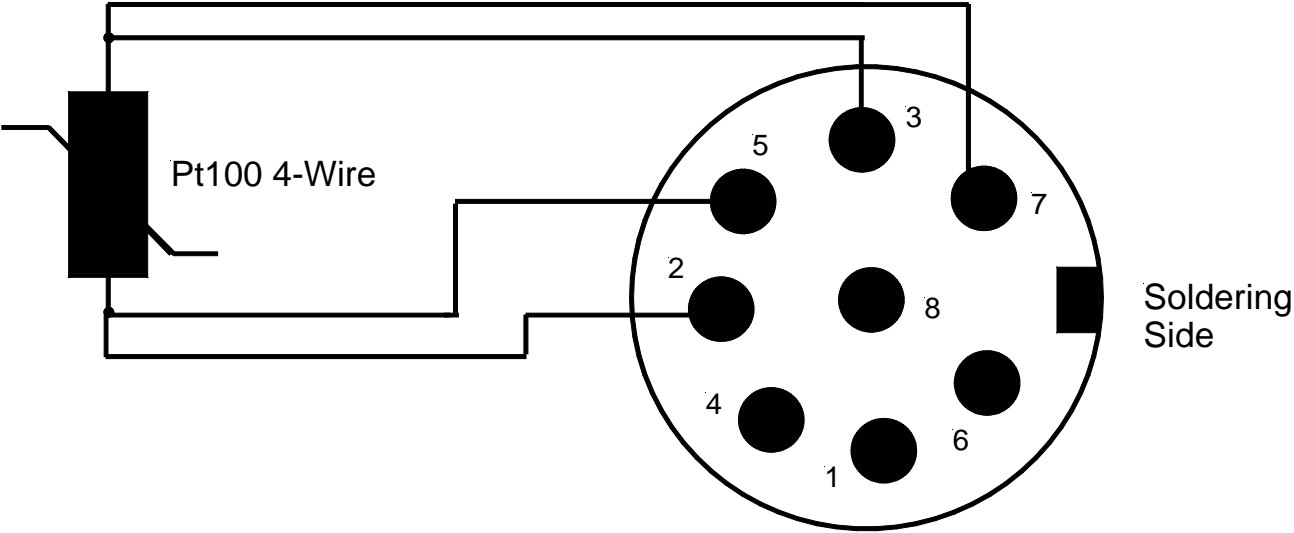

Connector layout thermocouple (series P600)

## Measuring channel 1 / 2

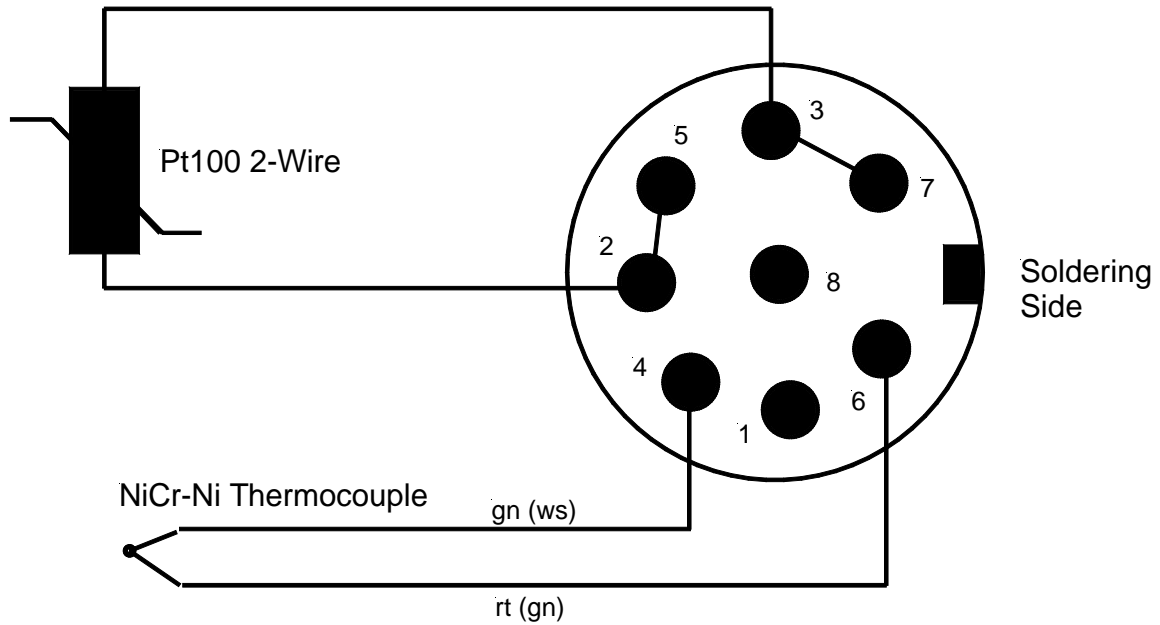

### International colours of thermocouples

Thermocouple	DIN 43 722	DIN 43 710	ANSI MC 96.1
<b>Type R</b> Pt13%Rh-Pt	<b>orange</b> + orange - white	<b>white</b> + red - white	<b>green</b> + black - red
<b>Type Ss</b> Pt10%Rh-Pt	<b>orange</b> + orange - white	<b>white</b> + red - white	<b>green</b> + black - red
<b>Type J</b> Fe-CuNi	<b>black</b> + black - white		<b>black</b> + white - red
<b>Type T</b> Cu-CuNi	<b>brown</b> + brown - white		<b>blue</b> + blue - red
<b>Type K</b> NiCr-Ni	<b>green</b> + green - white	<b>green</b> + red - green	<b>yellow</b> + yellow - red
<b>Type N</b> NiCrSi-NiSi	<b>pink</b> + pink - white		
<b>Type L</b> Fe-CuNi		<b>brown</b> + red - blue	

Connector layout of a probe for flow Mini Air6 (series P650/P655/670)

# Measuring channel 1 / 2

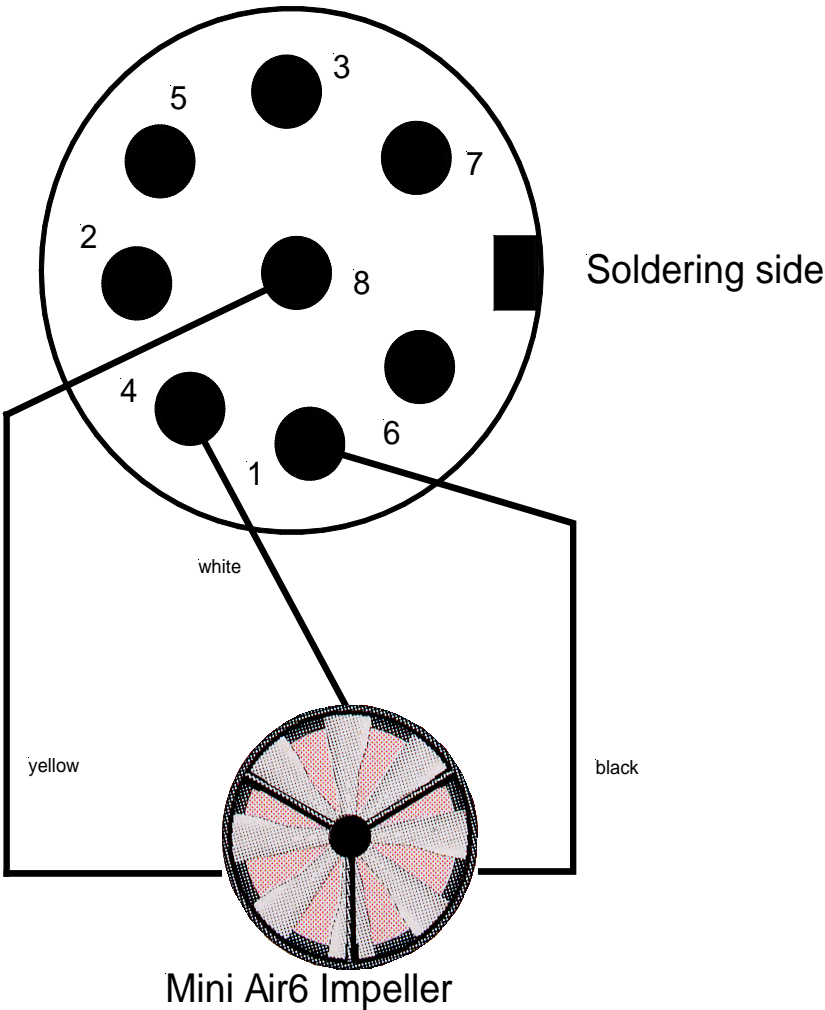

RS232 – PC-adapter cable (Connector layout)

Measuring channel 1 / 2

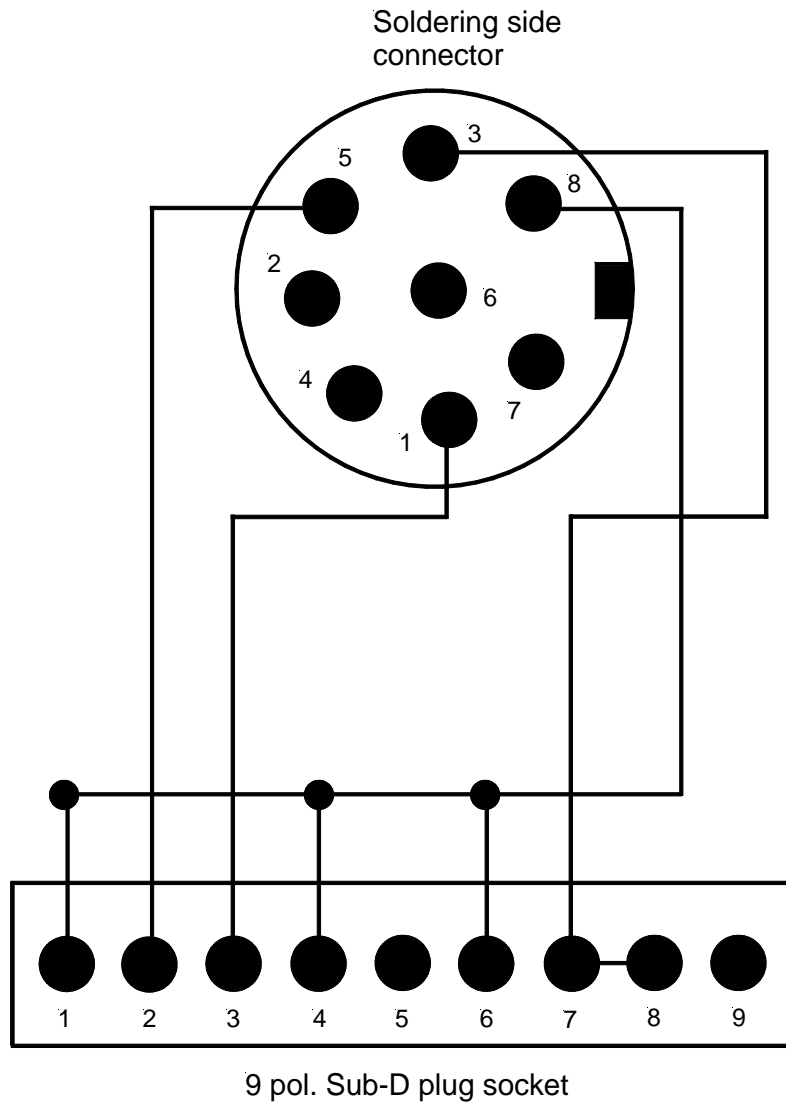

## Adaptor DIN Connector for Thermocouples Socket (series P600)

Measuring channel 1 / 2

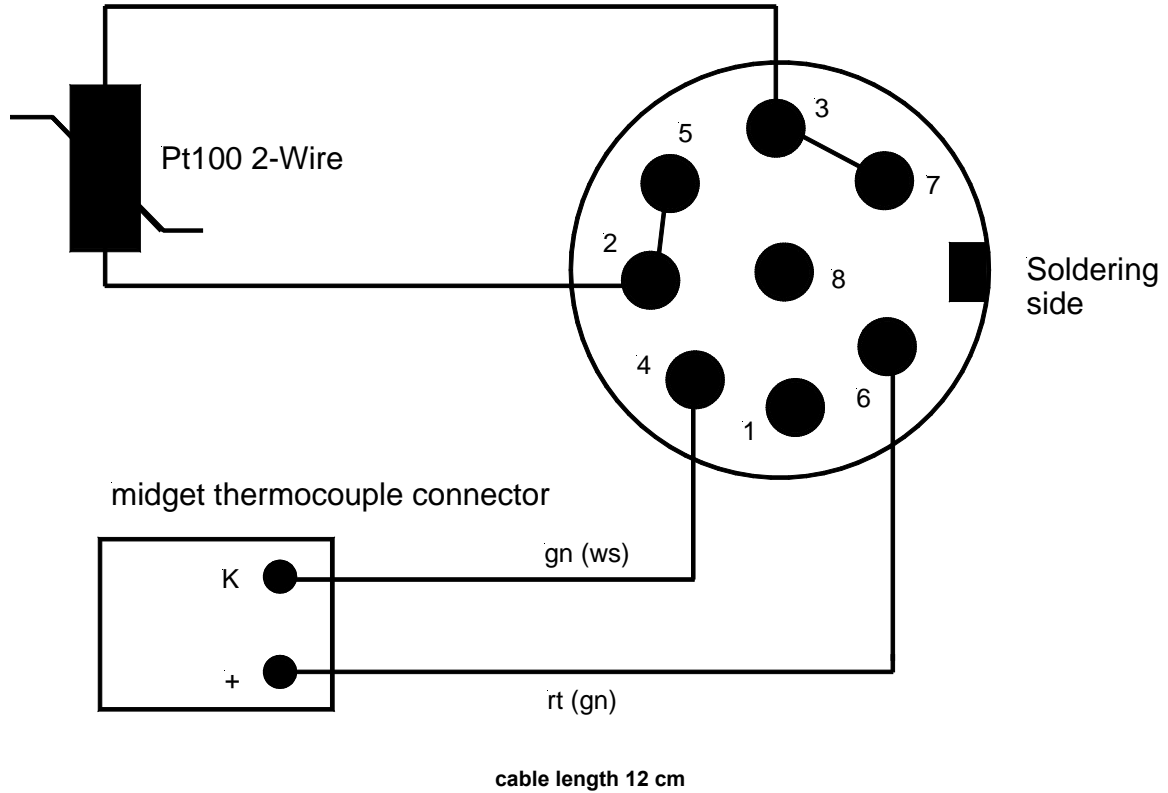

### International colours for thermocouples

Thermocouple	DIN 43 722	DIN 43 710	ANSI MC 96.1
<b>Type R</b> Pt13%Rh-Pt	<b>orange</b> + orange - white	<b>white</b> + red - white	<b>green</b> + black - red
<b>Type s</b> Pt10%Rh-Pt	<b>orange</b> + orange - white	<b>white</b> + red - white	<b>green</b> + black - red
<b>Type J</b> Fe-CuNi	<b>black</b> + black - white		<b>black</b> + white - red
<b>Type T</b> Cu-CuNi	<b>brown</b> + brown - white		<b>blue</b> + blue - red
<b>Type K</b> NiCr-Ni	<b>green</b> + green - white	<b>...green</b> + red - green	<b>yellow</b> + yellow - red
<b>Type N</b> NiCrSi-NiSi	<b>pink</b> + pink - white		
<b>Type L</b> Fe-CuNi		<b>brown</b> + red - blue	

Wall Power Supply Series P500 / P600

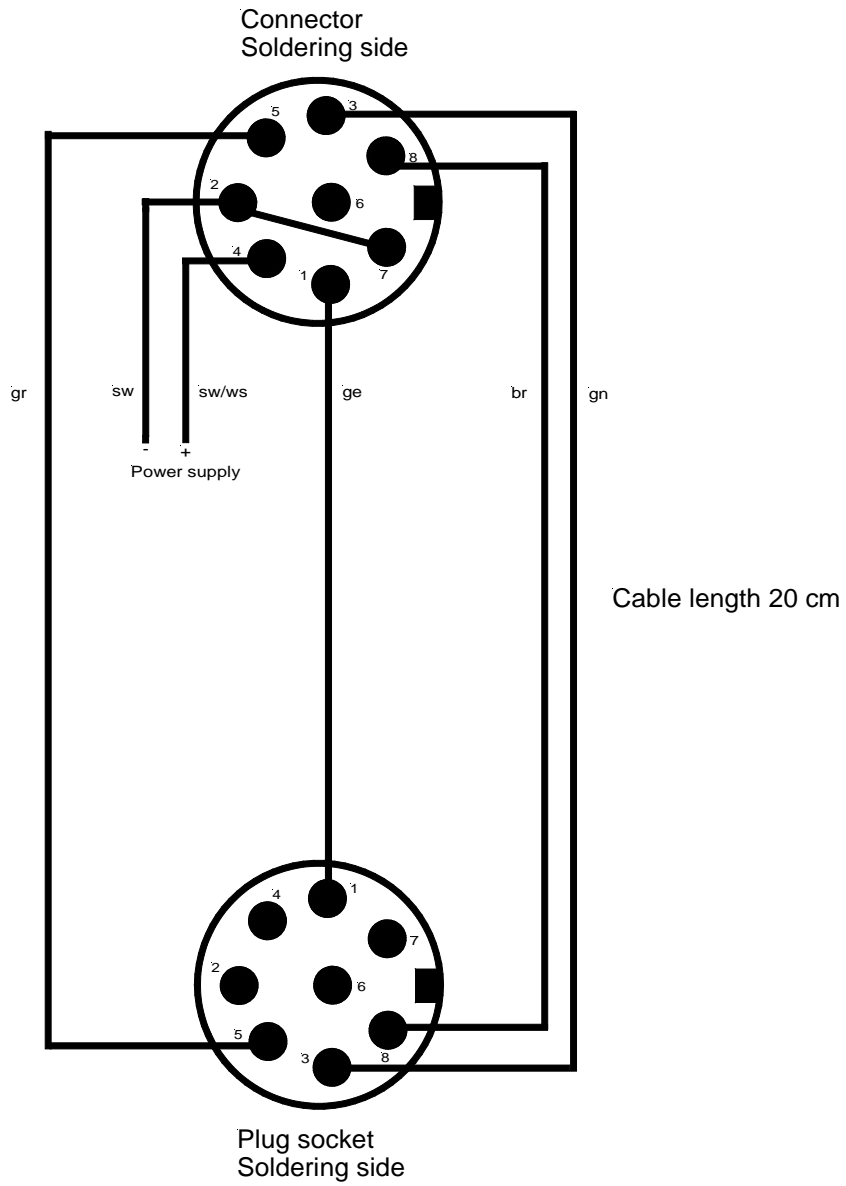

## 7. Data of probe-calibration

Our quality-probes are the main reason for the precision and quality of your measuring. To facilitate the exchange of a probe without a loss of precision, our probes were measured in our company and added with a code that describes the characteristic line of the probe. The code is attached well visible on a label on the probe.

If you change the probe you have to enter the code into the measuring instrument. In order to avoid any problems later on (esp. if the probe is installed somewhere hard accessible, or if there are several of those external probes in use), we recommend to note down the two values:

Art.Nr.: \_\_\_\_\_  
Appellation: \_\_\_\_\_  
Serial number: \_\_\_\_\_  
Calibration data: \_\_\_\_\_  
\_\_\_\_\_  
\_\_\_\_\_

Art.Nr.: \_\_\_\_\_  
Appellation: \_\_\_\_\_  
Serial number: \_\_\_\_\_  
Calibration data: \_\_\_\_\_  
\_\_\_\_\_  
\_\_\_\_\_

Art.Nr.: \_\_\_\_\_  
Appellation: \_\_\_\_\_  
Serial number: \_\_\_\_\_  
Calibration data: \_\_\_\_\_  
\_\_\_\_\_  
\_\_\_\_\_

Art.Nr.: \_\_\_\_\_  
Appellation: \_\_\_\_\_  
Serial number: \_\_\_\_\_  
Calibration data: \_\_\_\_\_  
\_\_\_\_\_  
\_\_\_\_\_

Art.Nr.: \_\_\_\_\_  
Appellation: \_\_\_\_\_  
Serial number: \_\_\_\_\_  
Calibration data: \_\_\_\_\_  
\_\_\_\_\_  
\_\_\_\_\_

## 8. Unit diagram

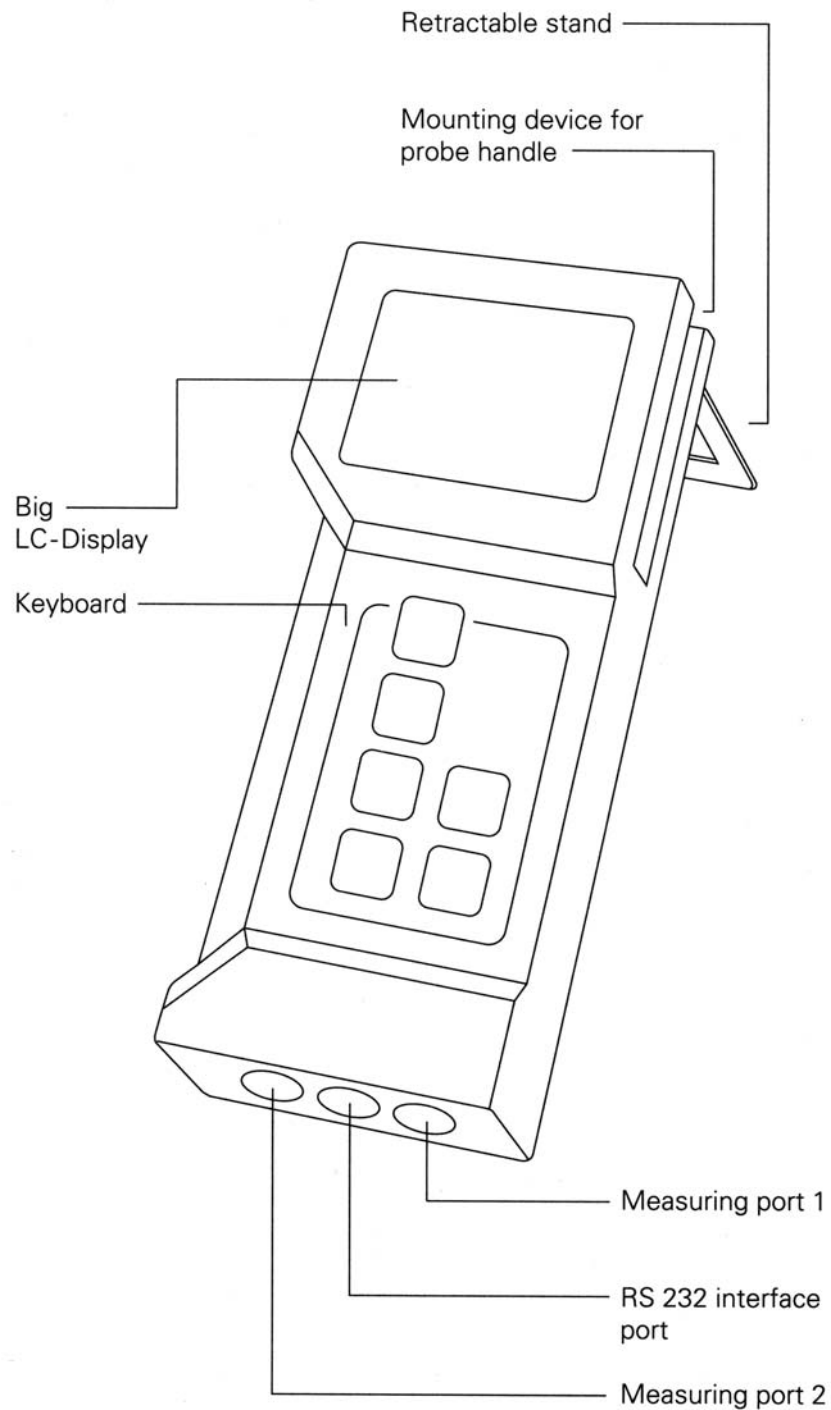

Una visión general de todos los medidores encuentra usted aquí:

<http://www.pce-iberica.es/instrumentos-de-medida/medidores.htm>

Una visión general de todos los instrumentos medida encuentra usted aquí:

<http://www.pce-iberica.es/instrumentos-de-medida/instrumentos-medida.htm>

**ATENCIÓN:** “Este equipo no dispone de protección ATEX, por lo que no debe ser usado en atmósferas potencialmente explosivas (polvo, gases inflamables).”

Puede entregarnos el aparato para que nosotros nos deshagamos del mismo correctamente. Podemos reutilizarlo o entregarlo a una empresa de reciclaje cumpliendo así con la normativa vigente.

R.A.E.E. – Nº 001932

